



Coto Technology

7301-05-1011

Tau Wae:

7301-05-1011

Kaihanga / Waitohu:

Coto Technology

Whakaahuatanga hua

RELAY REED SPST 500MA 5V

Ngā Rauemi:

 7301-05-1011.pdf

RoHS Tūnga

 Whakahaerehia te kore utu / RoHS

Tuhinga mai i

Hong Kong

Te Ara Tuhi

DHL/Fedex/TNT/UPS/EMS

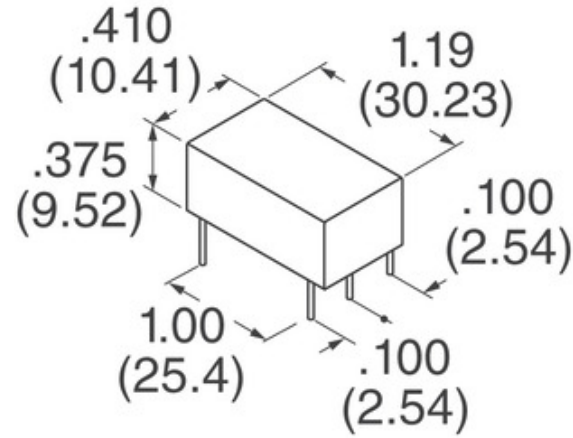

TONO MO TE WHAKAHUA

Ko te whakaahua he tohu. Tirohia nga korero mo nga taipitopito hua.







Ngā whakaaturanga o 7301-05-1011

TAU WAE	7301-05-1011
KAIHANGA	Coto Technology
WHAKAAHUATANGA	RELAY REED SPST 500MA 5V
WHAKAHAERE TOKO WHAKAHAERE / ROHS TŪNGA	Whakahaerehia te kore utu / RoHS
PEPA RARAUNGA	 7301-05-1011.pdf
TAHURI I TE NGAOHIHI (MAX)	3.75 VDC
WHAKAKOREHIA TE NGAOHIHI (MIN)	0.4 VDC
KĀHUA WHAKAMUTUNGA	PC Pin
WHAKAOHO WHAKAWHITI	500VAC, 500VDC - Max
RAUPAPA	7000
WĀ WHAKAORA	0.1ms
PACKAGING	Tube
TAE MAHI	-20°C ~ 85°C
WHAKAMAHIA TE WA	1ms
MOMO TAE	Through Hole
TAUMATA WHAKAARO MOE (MSL)	1 (Unlimited)
TE TAE KAITUKU TAEKE	28 Weeks
WHAKAHAERE TOKO WHAKAHAERE / ROHS TŪNGA	Lead free / RoHS Compliant
NGĀ ĀHUATANGA	Diode, Electrostatic Shield
WHAKAAETANGA WHAKATAURANGA (ANEI)	500mA
WHAKAAETANGA MEA	-
PUKA PUKA WHAKAPĀ	SPST-NO (1 Form A)
KOHIKOHI NGAOHIKO	5VDC
MOMO MOMO	Non Latching
KO TE WHAKAAETANGA MIIHINI	175 Ohms
KOHIKOHI MIIHINI	-
KOHIKOHI KEI TE AUKATI	28.6mA

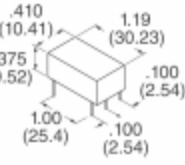
Ngā tūtohu e hāngai ana

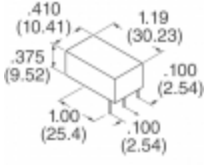
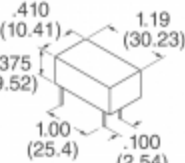
Coto Technology 7301-05-1011	Kaitoha 7301-05-1011	Kaiwhakarato 7301-05-1011
Utu 7301-05-1011	Pikitia 7301-05-1011	Whakaahua 7301-05-1011
7301-05-1011 Pepa Raraunga PDF	7301-05-1011 Tango Whakahoki	Tapunga 7301-05-1011
Hokona 7301-05-1011	Hokona 7301-05-1011	Hokona Coto Technology 7301-05-1011
Coto Technology 7301-05-1011	Kaiwhakarato Coto Technology	Kaitoha Kaatawhai Coto Technology
Coto Technology 7301-05-1011		

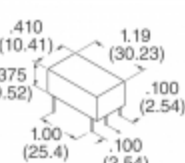
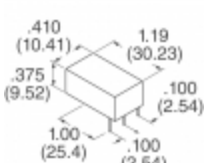
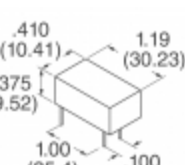
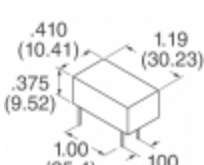
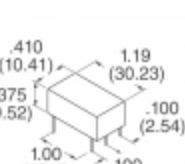
Ngā Hua e hāngai ana

 <p>7301-12-1011 Kaihanga: Coto Technology Whakaahuatanga: RELAY REED SPST 500MA 12V I roto i te taonga: Out stock</p> <p>RFQ</p>	 <p>7300N Kaihanga: Apex Tool Group Whakaahuatanga: AO102 ARBOR MT/JT I roto i te taonga: Out stock</p> <p>RFQ</p>
 <p>73009W 0081000 Kaihanga: Belden Whakaahuatanga: CBL 9COND 20AWG I roto i te taonga: Out stock</p> <p>RFQ</p>	 <p>7301-05-1100 Kaihanga: Coto Technology Whakaahuatanga: RELAY REED SPST 500MA 5V I roto i te taonga: Out stock</p> <p>RFQ</p>
 <p>7301-05-1001 Kaihanga: Coto Technology Whakaahuatanga: RELAY REED SPST 500MA 5V I roto i te taonga: Out stock</p> <p>RFQ</p>	 <p>73009W 008500 Kaihanga: Belden Whakaahuatanga: CBL 9COND 20AWG I roto i te taonga: Out stock</p> <p>RFQ</p>
 <p>7301-12-1010 Kaihanga: Coto Technology Whakaahuatanga: RELAY REED SPST 500MA 12V I roto i te taonga: Out stock</p> <p>RFQ</p>	 <p>7301-12-1100 Kaihanga: Coto Technology Whakaahuatanga: RELAY REED SPST 500MA 12V I roto i te taonga: Out stock</p> <p>RFQ</p>
 <p>7301-05-1000 Kaihanga: Coto Technology Whakaahuatanga: RELAY REED SPST 500MA 5V I roto i te taonga: 144 pcs</p> <p>RFQ</p>	 <p>7301-12-1000 Kaihanga: Coto Technology Whakaahuatanga: RELAY REED SPST 500MA 12V I roto i te taonga: Out stock</p> <p>RFQ</p>
 <p>7301-05-1010 Kaihanga: Coto Technology Whakaahuatanga: RELAY REED SPST 500MA 5V I roto i te taonga: Out stock</p> <p>RFQ</p>	 <p>7301-05-1110 Kaihanga: Coto Technology Whakaahuatanga: RELAY REED SPST 500MA 5V I roto i te taonga: 137 pcs</p> <p>RFQ</p>